



synea FUSION
DENTAL

Instructions for use



CE
0297

Profin® Reciprocating contra-angle handpiece with light

WG-67 LT

Profin® Reciprocating contra-angle handpiece without light

WG-67 A

Contents

W&H Symbols	3 – 4
1. Introduction	5 – 7
2. Safety notes	8 – 9
3. Product description	10
4. Operation	11 – 14
Assembly / Removal, To change files/tips, Test run	
5. Hygiene and maintenance	15 – 24
General, Pre-disinfection, Manual cleaning, Manual disinfection, Mechanical cleaning and disinfection, Oil service, Sterilization	
6. W&H Accessories	25
7. Technical data	26 – 28
8. Recycling and disposal	29
Explanation of warranty terms	30
Authorized W&H service partners	31

W&H Symbols

Symbols in the Instructions for use



WARNING!
(risk of injury)



ATTENTION!
(to prevent
damage occurring)



General explanations,
without risk to
persons or objects



**Do not dispose of
with domestic waste**





UL Component Recognition
Mark indicates compliance
with Canadian and U.S.
requirements

W&H Symbols

Symbols on the instrument

 CE 0297
from the manufacturer

 Thermo washer disinfectable

 Sterilizable up to the
stated temperature

 Date of manufacture

 Data Matrix Code for
product identification, e.g.
in hygiene / maintenance
process

REF Catalogue number

SN Serial number

rpm rpm = min-1
(Revolutions per minute)

1. Introduction

Customer satisfaction has absolute priority in the W&H quality policy. This W&H product has been developed, manufactured and subjected to final inspection according to legal regulations, quality norms and industry standards.

For your safety and the safety of your patients

Prior to initial use please read the Instructions for use. These explain how to use your W&H product and guarantee a smooth and efficient operation.

Intended use

The reciprocating contra-angle handpiece is intended for the following applications:

Finishing of cavities / crown cement and restorations, setting of inlays with vibration, finishing and polishing in the interdental region and stripping.

Misuse may damage the contra-angle handpiece and hence cause risks and hazards for patients, users and third parties.

Qualifications of the user

We have based our development and design of the dental handpiece and contra-angle on the »dentists, dental hygienists, dental employees (prophylaxis) and dental assistants« target group.



Production according to EU directive

The contra-angle handpiece is a medical product according to the EU-directive 93/42/EEC.



Responsibility of the manufacturer

The manufacturer can only accept responsibility for the safety, reliability and performance of the contra-angle handpiece when it is used in compliance with the following directions:

- > The contra-angle handpiece must be used in accordance with these Instructions for use.
- > The contra-angle handpiece has no components that can be repaired by the user. Assembly, modifications or repairs must only be undertaken by an authorized W&H service partner (see page 31).

Skilled application

The contra-angle handpiece is intended only for skilled application in dentistry according to its purpose of use in compliance with the valid health and safety at work regulations, the valid accident prevention regulations as well as in compliance with these Instructions for Use. The contra-angle handpiece should be prepared for use and maintained by staff who have been trained in procedures for infection control, personal safety and patient safety. Improper use, (e.g. through poor hygienic maintenance), non-compliance with our instructions or the use of accessories and spare parts which are not approved by W&H, invalidates all claims under warranty and any other claims.

Service

In case of service or repair contact an authorized W&H service partner (see page 31).

Service and maintenance work must only be carried out by an authorized W&H service partner.

2. Safety notes



- > Always ensure the correct operating conditions and cooling function.
- > Always ensure that sufficient and adequate cooling is delivered and ensure adequate suction. In case of coolant supply failure, the contra-angle handpiece must be stopped immediately.
- > Use only non-contaminated, filtered, oil-free and dry compressed air to operate the contra-angle handpiece.
- > Check the contra-angle handpiece for damage and loose parts each time before using (e.g. press-button).
- > Do not operate the contra-angle handpiece if it is damaged.
- > Perform a test run prior to each treatment.
- > Run the rinse function for the dental unit once per day.



- > The operation of the contra-angle handpiece with light is permitted only on dental units which correspond to the standards IEC 60601-1 (EN 60601-1) and IEC 60601-1-2 (EN 60601-1-2).

The power supply unit for the dental unit must satisfy the following requirements to be guaranteed by the system assembler:

- > The compliance with the leakage currents of the application section must be guaranteed by the system assembler.
- > The secondary voltage must be non-earthed.
- > The secondary circuits must be protected against short-circuiting and overloading.

Hygiene and maintenance prior to initial use

The contra-angle handpiece is in a clean condition and sealed in PE-film when delivered. Lubricate the contra-angle handpiece prior to initial use. Sterilize contra-angle handpiece, tip ejector and nozzle cleaner.

- > Oil service page 21
- > Sterilization page 23

3. Product description handpiece

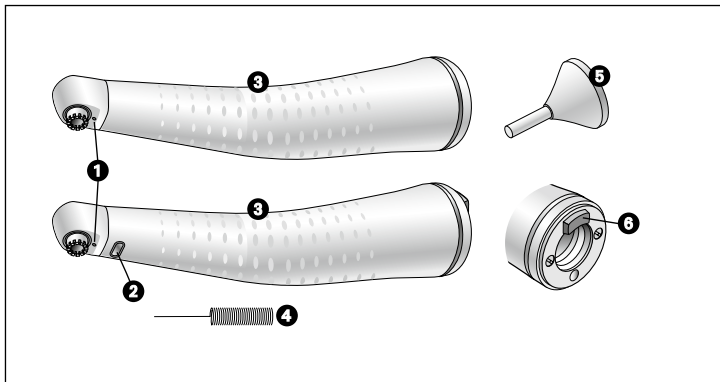

- ① Spray nozzles
- ② Compact glass rod (WG-67 LT)
- ③ Grip profile
- ④ Nozzle cleaner
- ⑤ Tip ejector
- ⑥ Support tab

4. Operation – Assembly / Removal

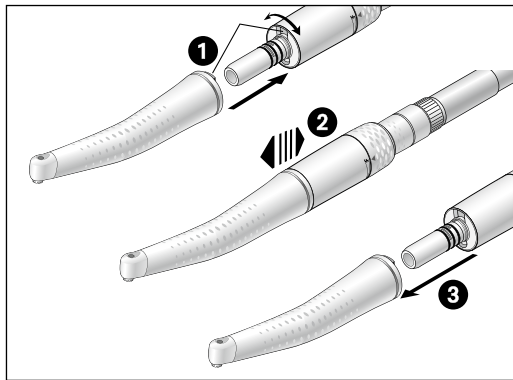

Do not assemble / remove during the operation!

- 1** Push the contra-angle handpiece onto the motor until it engages.
- 2** WG-67 LT: Push the contra-angle onto the motor and turn it until it engages audibly.
- 3** Check the connection to the motor is secure.
- 4** Remove the contra-angle handpiece by pulling in an axial direction.



Files/tips

The insert used carries out a reciprocating movement.

- > Use only files/tips which are in perfect condition. Follow the operating instructions of the manufacturer.
- > Insert file/tip only when the contra-angle handpiece is stationary.
- > Do not interfere with the running or slowing down of files/tips.

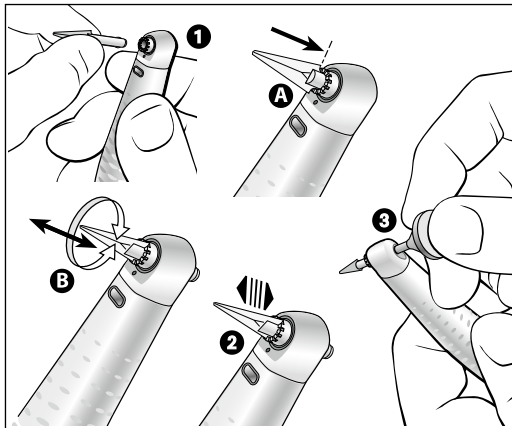

Changing files/tips

- 1** Insert the file/tip in the contra-angle until it engages.
 - > The file/tip rotates freely (360°) and can be fixed in 12 positions (30° steps) [A].
 - > Press the file/tip into the position required up to the limit stop [B].
- 2** Check secure location by applying slight axial tension.
- 3** Remove the file with the tip ejector.

Test run



Do not hold the contra-angle handpiece at eye level.

- > Insert the file/tip.
- > Start the contra-angle handpiece.
- > If you observe problems (e.g. vibrations, unusual noise, overheating, coolant supply failure or leakage) **stop the contra-angle handpiece immediately** and contact an authorized W&H service partner organization (see page 31).

5. Hygiene and maintenance



- Follow your country-specific directives, standards and guidelines for cleaning, disinfection and sterilization.
- > You can process the contra-angle handpiece manually or mechanically.



- > Wear protective clothing.
- > Remove the contra-angle handpiece from the motor.
- > Remove the file/tip.

- > Clean and disinfect the contra-angle handpiece **immediately after every treatment**, to flush out any liquid (such as blood, saliva etc.) and to prevent settling on the internal parts.

- > Sterilize the contra-angle handpiece following manual or mechanical cleaning, disinfection and lubrication.
- > Sterilize the nozzle cleaner following cleaning and disinfection.

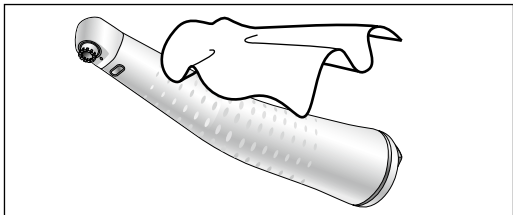

Pre-disinfection

- > If heavily soiled, clean first with disinfectant cloths.



Only use disinfectants that have no protein-fixing effects.

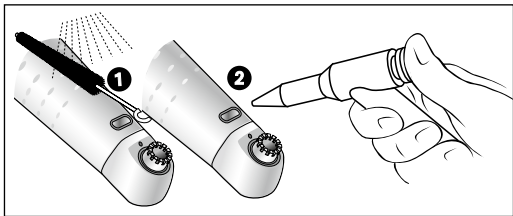

Manual cleaning internal and external

- 1 Rinse and brush off under demineralized water [$< 38\text{ }^{\circ}\text{C}$] / [$< 100\text{ }^{\circ}\text{F}$].
- 2 Remove any liquid residues [absorbent cloth, blow dry with compressed air].



Do not place the contra-angle handpiece in liquid disinfectant or in an ultrasonic bath.

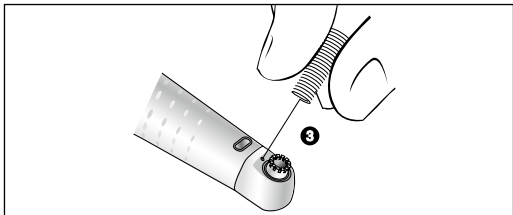

Cleaning of the spray nozzles

- ③ Clean spray nozzles carefully with the nozzle cleaner from dirt and deposits.



Clean and disinfect the nozzle cleaner in an ultrasonic bath / disinfection bath.

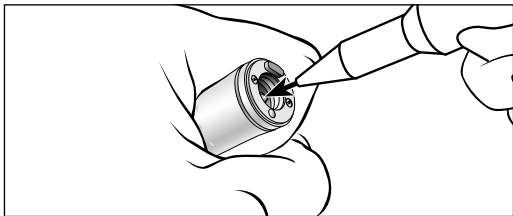

Cleaning of the coolant tubes

- > Blow through the coolant tube with the air syringe.



In the case of clogged up spray nozzles or coolant tubes contact an authorized W&H service partner [see page 31].

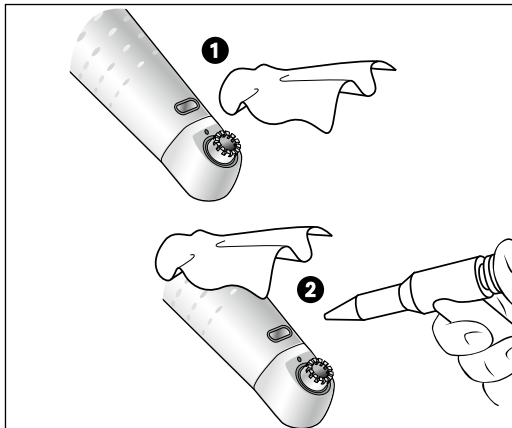

Cleaning of the optic outlet



Avoid scratching of the optic outlet!

- 1** Wash the optic outlet with cleaning fluid and a soft cloth.
- 2** Blow the optic outlet dry with air syringe or dry it carefully with a soft cloth.



Carry out a visual inspection after each cleaning process. Do not use the contra-angle handpiece if the optic outlet is damaged and contact an authorized W&H service partner (see page 31).

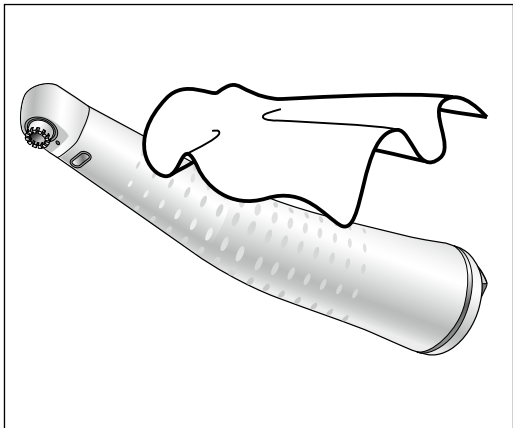

Manual disinfection

 W&H recommends wiping down with disinfectant.

- > Use only disinfectants which do not contain chlorine and which are certified by officially recognized institutes.
- > Note the manufacturer's specifications for the use of the disinfectants.



After manual cleaning, disinfection and lubrication you must carry out a final thermal disinfection (unwrapped) or sterilization (wrapped) in a class B or S steam sterilizer (according to EN 13060).

Mechanical cleaning and disinfection internal and external



The contra-angle handpiece can be cleaned and disinfected in a thermo washer disinfectant.



W&H recommends processing with thermo washer disinfectant.

> Note the manufacturer's specifications on equipment, cleaning agents and detergents.



> Make sure, that the contra-angle handpiece is completely dry internally and externally after thermo washer disinfection. Remove any liquid residues with compressed air.

> Lubricate the dry contra-angle handpiece immediately after thermo washer disinfection.

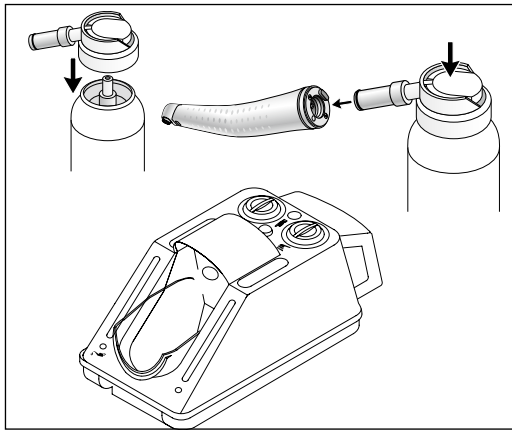

Daily oil service

- ❶ **Only with W&H Service Oil F1, MD-400**
 - > Follow the Instructions for use of the oil spray can.or
- ❷ **Only with W&H Assistina**
 - > See Instructions for use of Assistina.

Recommended lubrication cycles

- > Essential after every internal cleaning
 - > Before each sterilization
- or
- > After 30 minutes of use or at least once daily

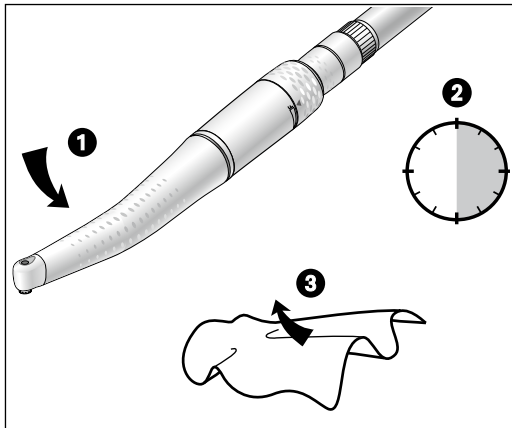

Test run following oil service

- 1 Place the contra-angle handpiece with the head downwards.
- 2 Start the contra-angle handpiece for 30 seconds to remove excess oil.
 - > Repeat the complete hygiene and maintenance process at any sign of dirt re-emerging.
- 3 Wipe the contra-angle handpiece with gauze or soft cloth.

Sterilization and storage



W&H recommends sterilization according to EN 13060, class B

- > **Observe the device manufacturer's instructions.**
- > **Clean, disinfect and lubricate prior to sterilization.**
- > **Wrap the contra-angle handpiece and the accessory in sterile goods packing according to EN 868-5.**
- > **Make sure that you only remove dry sterile goods from the sterilizer.**
- > **Store sterile goods dust-free and dry.**



The standard ISO 7785-2 / ISO 14457 stipulates a durability of at least 250 sterilization cycles.

In the case of the contra-angle handpiece from W&H, we recommend you to have a regular service carried out after 1000 sterilization cycles or one year.

Approved sterilization procedures



Follow your country-specific directives, standards and guidelines.

- > Steam sterilization class B with sterilizers in accordance with EN 13060.
Sterilization holding time a minimum of 3 minutes at 134 °C (273.2 °F)

or

- > Steam sterilization class S with sterilizers in accordance with EN 13060.
The sterilizer manufacturer must give its express approval for the sterilization of contra-angle handpieces.
Sterilization holding time a minimum of 3 minutes at 134 °C (273.2 °F)

6. W&H Accessories

Use only original W&H accessories and spare parts!

Suppliers: W&H partners

301	W&H Assistina
10940021	W&H Service Oil F1, MD-400 (6 pcs)
01603400	Tip ejector
02015101	Nozzle cleaner
02038200	Spray cap with spray nozzle for contra-angle handpieces

7. Technical data

	WG-67 LT / WG-67 A
Transmission ratio	2 : 1
Colour coding	1 green ring
Motor coupling	ISO 3964
Recommended files/tips	DENTATUS LDT and LTA *
Max. overall length	determined by the files/tips available
Chucking	sliding chuck *
Max. motor speed [min ⁻¹]	20,000
Spray flow rate acc. to ISO 7785-2 [ml/min]	> 50
Water setting range (rec. water pressure) ** [bar]	0.5 – 2
Chip air setting range (rec. chip air pressure) ** [bar]	1,5 – 3
Chip air consumption at 2 bar [NI/min]	> 1,5

* see page 27



* A shorter chuck length is not possible. In this case or when using other files/tips, the user must ensure by correct selection of the operating conditions that there is no danger to the user, patient or third parties.

**The chip air / water pressure must be set at the same time
The chip air must be higher than the water pressure

Temperature information

Temperature of the contra-angle handpiece at the operator side:	max. 55 °C (131 °F)
Temperature of the contra-angle handpiece at the patient side:	max. 50 °C (122 °F)
Temperature of the working part (rotary instrument):	max. 41 °C (105.8 °F)

Physical characteristics

Temperature for storage and transport:	-40 °C to +70 °C (-40 °F to +158 °F)
Air humidity for storage and transport:	8 % to 80 % (relativ), non-condensing
Ambient temperature during operation:	+10 °C to +35 °C (+50 °F to +86 °F)
Air humidity during operation:	15 % to 80 % (relativ), non-condensing

8. Recycling and disposal

Recycling

W&H considers that it has a special duty towards the environment. The contra-angle handpiece along with its packaging has been designed to be as environmentally friendly as possible.



Disposal of the contra-angle handpiece

Follow your country-specific laws, directives, standards and guidelines.

Ensure that the parts are not contaminated on disposal.

Disposal of the packaging material

All packaging materials have been selected according to environmentally compatible and disposal aspects and can be recycled. Please send old packaging materials to the relevant collection and reprocessing system. This way, you will contribute to the recycling of raw materials and the avoidance of waste.

Explanation of warranty terms

This W&H product has been manufactured with great care by highly qualified specialists. A wide variety of tests and controls guarantee faultless operation. Please note that claims under warranty can only be validated when all the directions in the instructions for use have been followed.

As manufacturer, W&H is liable for material or manufacturing defects within a warranty period of 24 months from the date of purchase.

We accept no responsibility for damage caused by incorrect handling or by repairs carried out by third parties not authorized to do so by W&H!

Claims under warranty – accompanied by proof of purchase – must be sent to the vendor or to an authorized W&H service partner. The provision of service under warranty extends neither the warranty period nor any other guarantee period.

24 months warranty

Authorized W&H service partners

Find you nearest W&H service partner at <http://wh.com>

Simply go to the menu option »Service« for full details. Alternatively please contact:

W&H (UK) LIMITED, 6 Stroud Wood Business Centre, Park Street, St Albans, Herts AL2 2NJ, United Kingdom
t + 44 1727 874990, f + 44 1727 874628, E-Mail: technical.uk@wh.com

W&H Impex Inc., 6490 Hawthorne Drive, Windsor, Ontario, N8T 1J9, Canada
t + 1 800 2656277, + 1 519 9446739, f + 1 519 9746121, E-Mail: service.ca@wh.com

W&H Impex Inc., 14300 Henn Rd., Dearborn, MI 48126, USA
t + 1 800 2656277, + 1 519 9446739, f + 1 519 9746121, E-Mail: service.us@wh.com

W&H Austria GmbH, Ignaz-Glaser-Straße 53, 5111 Bürmoos, Austria
t + 43 6274 6236-239, f + 43 6274 6236-890, E-Mail: office.at@wh.com

A-DEC AUSTRALIA CO. INC., Unit 8, 5-9 Ricketty Street, Mascot NWS 2020, Australia
t + 61 2 83324000, f + 61 2 83324099, E-Mail: a-dec@a-dec.com.au

Manufacturer

W&H Dentalwerk Bürmoos GmbH

Ignaz-Glaser-Straße 53, 5111 Bürmoos, Austria

t + 43 6274 6236-0,

office@wh.com

f + 43 6274 6236-55

wh.com

Form-Nr. 50613 AEN

Rev. 002 / 19.01.2015

Subject to alterations