

PEOPLE HAVE PRIORITY



Instructions for use



CE
0297

syneq^{VISION}

Turbine handpieces with light
TK-100 L / TK-98 L / TK-97 L / TK-94 L
TK-100 LM / TK-98 LM / TK-97 LM / TK-94 LM

Contents

W&H Symbols	3 – 4
1. Introduction	5 – 7
2. Safety notes	8 – 11
3. Product description	12 – 13
4. Operation	14 – 17
Assembly / Removal, To change rotary instrument, Test run	
5. Hygiene and maintenance	18 – 29
General, Pre-disinfection, Manual cleaning, Manual disinfection, Mechanical cleaning and disinfection, Oil service, Sterilization	
6. W&H Accessories	30
7. Technical data	31 – 33
8. Recycling and disposal	34
Explanation of warranty terms	35
Authorized W&H service partners	37

W&H Symbols

Symbols in the Instructions for use



WARNING!
(risk of injury)



ATTENTION!
(to prevent damage
occurring)



General explanations,
without risk to
persons or objects



**Do not dispose of
with domestic waste**





UL Component Recognition
Mark indicates compliance
with Canadian and U.S.
requirements

W&H Symbols

Symbols on the instrument

 CE 0297
from the manufacturer

 Thermo washer disinfectable

 135°C
Sterilizable up to the
stated temperature

 Date of manufacture

 Data Matrix Code for
product identification, e.g.
in hygiene / maintenance
process

REF Catalogue number

SN Serial number

1. Introduction

Customer satisfaction has absolute priority in the W&H quality policy. This W&H product has been developed, manufactured and subjected to final inspection according to legal regulations, quality norms and industry standards.

For your safety and the safety of your patients

Prior to initial use please read the Instructions for use. These explain how to use your W&H product and guarantee a smooth and efficient operation.

Intended use

The dental turbine is intended for the following applications: Removal of decayed materials, cavities and crown cement, removal of fillings, finishing of tooth and restoration surfaces.

Misuse may damage the turbine handpiece and hence cause risks and hazards for patients, users and third parties.

Qualifications of the user

We have based our development and design of the turbine handpiece on the »dentists, dental hygienists, dental employees (prophylaxis) and dental assistants« target group.



Production according to EU directive

The turbine handpiece is a medical product according to the EU directive 93/42/ECC.



Responsibility of the manufacturer

The manufacturer can only accept responsibility for the safety, reliability and performance of the turbine handpiece when it is used in compliance with the following directions:

- > The turbine handpiece must be used in accordance with these Instructions for use.
- > The turbine handpiece has no components that can be repaired by the user. Assembly, modifications or repairs must only be undertaken by an authorized W&H service partner (see page 6).

Skilled application

The turbine handpiece is intended only for skilled application in the dental or medical field according to its purpose of use in compliance with the valid health and safety at work regulations, the valid accident prevention regulations as well as in compliance with these Instructions for use.

The turbine handpiece should be prepared for use and maintained by staff who have been trained in procedures for infection control, personal safety and patient safety. Improper use, (e.g. through poor hygiene and maintenance), non-compliance with our instructions or the use of accessories and spare parts which are not approved by W&H, invalidates all claims under warranty and any other claims.

Service

In the event of malfunctions contact an authorized W&H service partner (see page 7). Service and maintenance work must only be carried out by an authorized W&H service partner.

2. Safety notes



- > The operation of the turbine handpiece with light is permitted only on dental units which correspond to the standards IEC 60601-1 (EN 60601-1) and IEC 60601-1-2 (EN 60601-1-2).

The power supply unit for the dental unit must satisfy the following requirements to be guaranteed by the system assembler:

- > Double insulation for the highest expected supply voltage must be provided between the primary and secondary power circuits.
- > Double insulation for the highest expected secondary voltage must be provided between the secondary voltage and protective earth (PE).
- > The secondary circuits must be galvanically isolated from each other.
- > The secondary circuits must be protected against short-circuiting and overloading (maximum 700mA).
- > The leakage currents of the applied part must be kept.
- > The secondary voltage must be limited to a maximum of 5 V AC / DC.



- > Always ensure the correct operating conditions and cooling function.
- > Always ensure that sufficient and adequate cooling is delivered and ensure adequate suction. In case of coolant supply failure, the turbine handpiece must be stopped immediately.
- > Use only non-contaminated, filtered, oil-free and dry compressed drive air to operate the turbine handpiece.
- > Check the turbine handpiece for damage and loose parts before each use (e.g. push-button).
- > Do not operate the turbine handpiece if it is damaged.
- > Perform a test run before each use.
- > Do not use the turbine handpiece at soft tissue wounds in the mouth (the air pressure can cause septic substances to penetrate the tissue, resp. can cause embolism).
- > Avoid contact between the instrument head and soft tissue (risk of burning due to the push-button heating up).
- > Run the rinse function for the dental unit once per day.
- > Do not use the turbine handpiece as light sensor.
- > Do not look directly into the optic outlet.



Danger zones M and G

In accordance with IEC 60601-1 / ANSI/AAMI ES 60601-1, the turbine handpiece is not suitable for use in potentially explosive atmospheres or with potentially explosive mixtures of anaesthetic substances containing oxygen or nitrous oxide.



The turbine handpiece is not suitable for use in oxygen enriched atmospheres.



Zone M, is defined as a »medical environment« and constitutes the part of a room in which potentially explosive atmospheres may form due to the use of anaesthetics or medical antiseptics and antibacterial soaps; such atmospheres are typically localized and temporary.

Zone M comprises a truncated pyramid below the operating table which is tilted outwards at a 30° angle.



Zone G, also known as an »enclosed medical gas system«, does not necessarily include areas enclosed around all sides, in which explosive mixtures are continuously or temporarily generated, directed or used in small quantities.



Risks due to electromagnetic fields

The functionality of implantable systems, such as cardiac pacemakers and implantable cardioverter defibrillator (ICD) can be affected by electric, magnetic and electromagnetic fields.

- > Find out if patient and user have implanted systems before using the product and consider the application.
- > Weigh the risks and benefits.
- > Keep the product away from implanted systems.
- > Make appropriate emergency provisions and take immediate action on any signs of ill-health.
- > Symptoms such as raised heartbeat, irregular pulse and dizziness can be signs of a problem with a cardiac pacemaker or ICD.

Hygiene and maintenance prior to initial use

The turbine handpiece is in a clean condition and sealed in PE-film when delivered. Lubricate the turbine handpiece prior to initial use. Sterilize the turbine handpiece and the nozzle cleaner.

- > Oil service page 24
- > Sterilization page 28

3. Product description

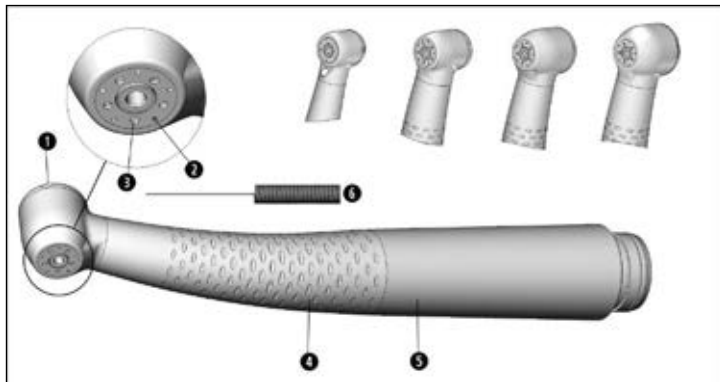

Turbine for Roto Quick coupling

- ① Push-button
- ② Spray nozzles
- ③ LED
- ④ Grip profile
- ⑤ Sheath
- ⑥ Nozzle cleaner

Product description

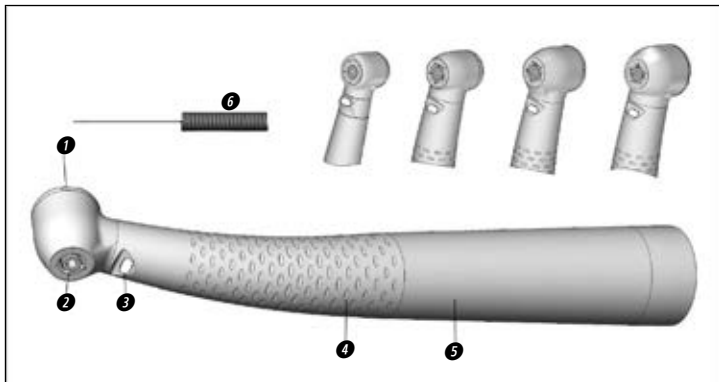

Turbine for Multiflex® coupling*

- ① *Push-button*
- ② *Spray nozzles*
- ③ *Compact glass rod*
- ④ *Grip profile*
- ⑤ *Sheath*
- ⑥ *Nozzle cleaner*

4. Operation – Assembly / Removal

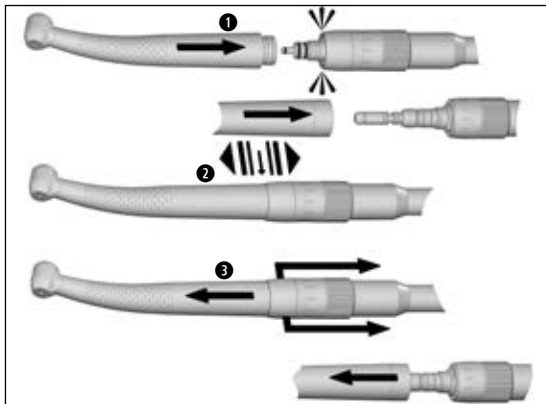

Do not assemble / remove the turbine handpiece during the operation!

- 1** Push the turbine handpiece onto the Roto Quick coupling / *Multiflex®** coupling.
- 2** Check the secure hold on the Roto Quick coupling.
- 3** Pull the retention sleeve of the Roto Quick coupling back and remove the turbine by pulling in an axial direction.
Remove the Multiflex® coupling by pulling in an axial direction.*



Rotary instruments

- > Use only rotary instruments which are in perfect condition and which have shanks that meet the requirements of the ISO 1797-1 standard. Follow the operating instructions of the manufacturer.
- > Insert the rotary instrument only when the turbine handpiece is stationary.
- > Do not interfere with the running or slowing down of the rotary instrument.
- > Do not activate the push-button of the turbine handpiece during operation or slowing down. This leads to detachment of the rotary instrument resp. heating of the push-button (risk of injury).

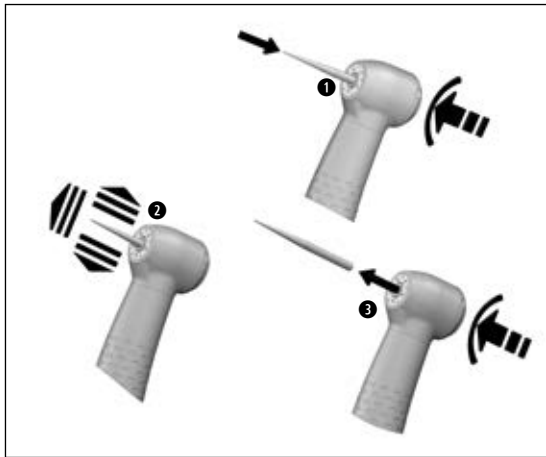

To change rotary instrument

- 1 Insert the rotary instrument.
Activate push-button, at the same time insert the rotary instrument until back stop.
- 2 Check secure location by applying slight axial tension.
- 3 Remove the rotary instrument by pushing the push-button.

Test run



Do not hold the turbine handpiece at eye level.

- > Insert the rotary instrument.
- > Start the turbine handpiece.
- > If you observe problems (e.g. vibrations, unusual noise, overheating, coolant supply failure or leakage) or discoloration of the LED, stop the turbine handpiece immediately and contact an authorized W&H service partner (see page 37).

5. Hygiene and maintenance



- Follow your country-specific directives, standards and guidelines for cleaning, disinfection and sterilization.
- > You can process the turbine handpiece manually or mechanically.



- > Wear protective clothing.
- > Remove the turbine handpiece from the Roto Quick coupling / *Multiflex®** coupling.
- > Remove the rotary instrument.

- > Clean and disinfect the turbine handpiece immediately **after every treatment**, to flush out any liquid (such as blood, saliva etc.) and to prevent settling on the internal parts.

- > Sterilize the turbine handpiece following manual or mechanical cleaning, disinfection and lubrication.
- > Sterilize the nozzle cleaner following manual cleaning and disinfection.

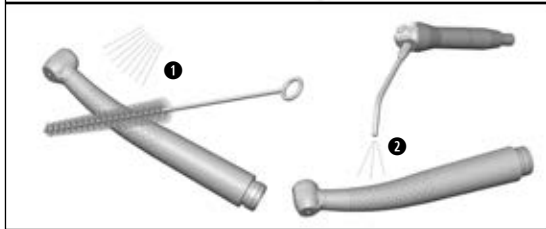
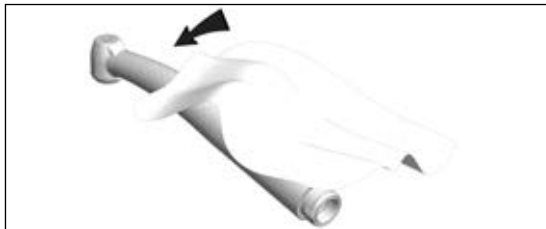

Pre-disinfection

- > If heavily soiled, clean first with disinfectant cloths.



Only use disinfectants that have no protein-fixing effects.

Manual cleaning internal and external

- ① Rinse and brush off under demineralized water (< 38 °C / < 100 °F).
- ② Remove any liquid residues (absorbent cloth, blow dry with compressed air).



Do not place the turbine handpiece in liquid disinfectant or in an ultrasonic bath.

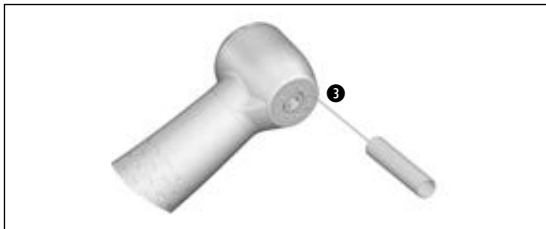

Cleaning of the spray nozzles

- ③ Clean spray nozzles carefully with the nozzle cleaner from dirt and deposits.



Clean and disinfect the nozzle cleaner in an ultrasonic bath /disinfection bath.



Cleaning of the coolant tubes

- > Blow through the coolant tube with the air syringe.



In the case of clogged up spray nozzles or coolant tubes contact an authorized W&H service partner [see page 20].

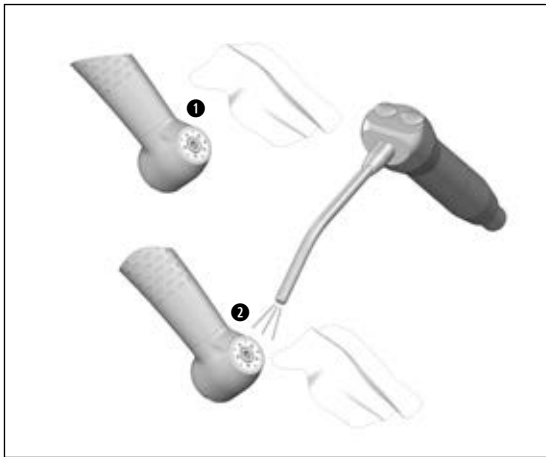

Cleaning of the optic outlet



Avoid scratching of the optic outlet!

- 1 Wash the optic outlet with cleaning fluid and a soft cloth.
- 2 Blow the optic outlet dry with air syringe or dry it carefully with a soft cloth.



Carry out a visual inspection after each cleaning process. Do not use the turbine handpiece if the optic outlet is damaged and contact an authorized W&H service partner [see page 21].

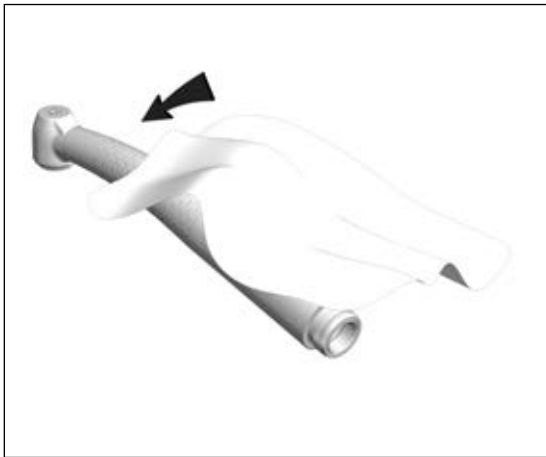

Manual disinfection



W&H recommends wiping down with disinfectant.

- > Use only disinfectants which do not contain chlorine and which are certified by officially recognized institutes.
- > Note the manufacturer's specifications for the use of the disinfectants.



After manual cleaning, disinfection and lubrication you must carry out a final thermal disinfection (unwrapped) or sterilization (wrapped) in a class B or S steam sterilizer (according to EN 13060).

Mechanical cleaning and disinfection internal and external



- W&H recommends mechanical cleaning and lubrication with W&H Assistina 3x3.
> Follow the instructions in the Assistina Instructions for use.



- The turbine handpiece can be cleaned and disinfected in a thermo washer disinfectant.
> Note the manufacturer's specifications on equipment, cleaning agents and detergents.



- > Make sure, that the turbine handpiece is completely dry internally and externally after thermo washer disinfection. Remove any liquid residues with compressed air.
> Lubricate the dry turbine handpiece immediately after thermo washer disinfection.

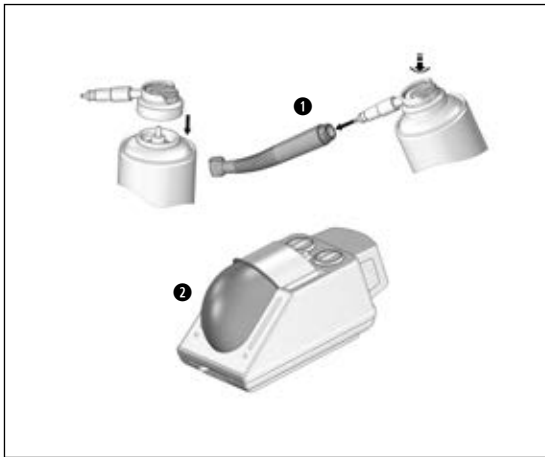

Daily oil service

- ❶ With W&H Service Oil F1, MD-400
 - > Follow the Instructions for use of the oil spray can.
- or
- ❷ With W&H Assistina
 - > See Instructions for use of Assistina.

Recommended lubrication cycles

- > Essential after every internal cleaning
 - > Before each sterilization
- or
- > After 30 minutes of use or
at least once daily



Weekly oil service of the chucking system

- ❶ Only with W&H Service Oil F1, MD-400
 - > Fit the spray cap REF 02036100 on the spray can.
 - > Hold the turbine handpiece firmly.
 - > Press the tip of the spray nozzle firmly into the chucking system.
 - > Spray for approx. 1 second.

or

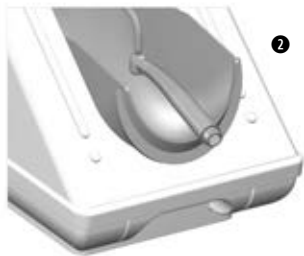

2 Only with W&H Assistina 301 plus

- > Fit the adaptor REF 02693000 onto the maintenance attachment.
Direct exit nozzle downwards.
- > Press the bur side of the turbine handpiece onto the adaptor from below.
- > Start the Assistina.
- > Press the turbine handpiece onto the adaptor for approx. 10 seconds.
- > Remove the turbine handpiece from the adaptor.
- > Close the cover of the Assistina and allow it to run for the remainder of the maintenance cycle [approx. 25 seconds].

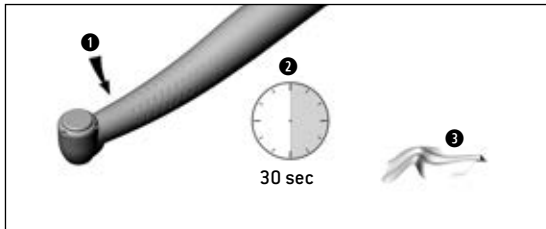

Test run following oil service

- 1 Place the turbine handpiece with the head downwards.
- 2 Start the turbine handpiece for 30 seconds to remove excessive oil.
 - > Repeat the complete hygiene and maintenance process at any sign of dirt re-emerging.
- 3 Wipe the turbine handpiece with gauze or soft cloth.

Sterilization and storage



W&H recommends sterilization according to EN 13060, class B

- > Observe the device manufacturer's instructions.**
- > Clean, disinfect and lubricate prior to sterilization.**
- > Wrap the turbine handpiece and the accessory in sterile goods packing according to EN 868-5.**
- > Make sure that you only remove dry sterile goods from the sterilizer.**
- > Store sterile goods dust-free and dry.**



The standard ISO 7785-1 / ISO 14457 stipulates a durability of at least 250 sterilization cycles.

In the case of the turbine handpiece from W&H, we recommend you to have a regular service carried out after 1000 sterilization cycles or one year.

Approved sterilization procedures



Follow your country-specific directives, standards and guidelines.

- > Steam sterilization class B with sterilizers in accordance with EN 13060.
Sterilization holding time a minimum of 3 minutes at 134 °C (273.2 °F)
or
- > Steam sterilization class S with sterilizers in accordance with EN 13060.
The sterilizer manufacturer must give its express approval for the sterilization of turbine handpieces.
Sterilization holding time a minimum of 3 minutes at 134 °C (273.2 °F)

6. W&H Accessories

Use only original W&H accessories and spare parts!

Suppliers: W&H partners

301	W&H Assistina
19922000	Assistina 3x2 (MB-200)
19923000	Assistina 3x3 (MB-300)
02690400	Assistina adaptor for all W&H products with Roto Quick system
02693000	Assistina adaptor for chucking system
10940021	W&H Service Oil F1, MD-400 (6 pcs)
02036100	Spray cap with spray nozzle for chucking system
02229200	Spray cap with spray nozzle for all W&H products with Roto Quick system
04396100	<i>Spray cap with nozzle for Multiflex® connection</i>
02015101	Nozzle cleaner

7. Technical data

Synea Vision		TK-94 L / TK-94 LM	TK-97 L / TK-97 LM	TK-98L / TK-98 LM	TK-100 L / TK-100 LM
Hose-side coupling according to standard		W&H Roto Quick / Multiflex ^{®*}	W&H Roto Quick / Multiflex ^{®*}	W&H Roto Quick / Multiflex ^{®*}	W&H Roto Quick / Multiflex ^{®*}
Instrument shaft diameter	ISO 1797-1 (mm)	1.6 – 0.01	1.6 – 0.01	1.6 – 0.01	1.6 – 0.01
max. length approved by W&H **	(mm)	16	21	25	25
max. operating part diameter	(mm)	1.5	2	2	2.5
minimum chucking length		until back stop	until back stop	until back stop	until back stop
idle mode speed (± 30.000)	(min ⁻¹)	410,000	400,000	360,000	330,000
Operating pressure Roto Quick connection (recommended operating pressure) [bar]		3 ± 0.3 (3)	3 ± 0.3 (3)	3 ± 0.3 (3)	3 ± 0.3 (3)
Operating pressure Multiflex ^{®*} connection (recommended operating pressure) [bar]		2.5 – 4 (3)	2.5 – 4 (3)	2.5 – 4 (3)	2.5 – 4 (3)
Exhaust air pressure	(bar)	< 0.5	< 0.5	< 0.5	< 0.5
Air consumption	(NI/min)	45	50	50	50
Water setting range (Recommended water pressure) ***	(bar)	0.7 – 2 (1.5)	0.7 – 2 (1.5)	0. – 2 (1.5)	0.7 – 2 (1.5)
Chip air setting range (Recommended chip air pressure) ***	(bar)	1.5 – 3 (2)	1.5 – 3 (2)	1.5 – 3 (2)	1.5 – 3 (2)
Coolant supply volume	ISO 7785-1 (ml/min)	> 50	> 50	> 50	> 50
Chip air consumption at 2 bar	(NI/min)	> 1.5	> 1.5	> 1.5	> 1.5
Supply voltage Roto Quick connection	(V DC or V AC)	3.2 ± 0.1	3.2 ± 0.1	3.2 ± 0.1	3.2 ± 0.1
Current consumption Roto Quick connection	(A)	0.4	0.4	0.4	0.4

* see page 32

* *Multiflex® is a registered trade mark of Kaltenbach & Voigt GmbH, Germany*



** When using longer rotary instruments the user must ensure by correct selection of the operating conditions, that there is no danger to the user, patient or third parties.

*** Chip air pressure / water pressure must be set at the same time
Chip air pressure must be higher than water pressure

Power and speed data of turbine handpieces are largely dependent on the quality of the turbine hoses used and may therefore differ from the specified values.

rpm = min⁻¹ (Revolutions per minute)

Temperature information

Temperature of the turbine handpiece at the operator side:	max. 55 °C (131 °F)
Temperature of the turbine handpiece at the patient side:	max. 50 °C (122 °F)
Temperature of the working part (rotary instrument):	max. 41 °C (105.8 °F)

Physical characteristics

Temperature for storage and transport:	-40 °C to +70 °C (-40 °F to +158 °F)
Air humidity for storage and transport:	8 % to 80 % (relative), non condensing
Ambient temperature during operation:	+10 °C to +35 °C (+50 °F to +86 °F)
Air humidity during operation:	15 % to 80 % (relative), non condensing

8. Recycling and disposal

Recycling

W&H considers that it has a special duty towards the environment. The turbine handpiece along with its packaging has been designed to be as environmentally friendly as possible.



Disposal of the turbine handpiece

Follow your country-specific laws, directives, standards and guidelines for the disposal of used electrical devices. Ensure that the parts are not contaminated on disposal.

Disposal of the packaging material

All packaging materials have been selected according to environmentally compatible and disposal aspects and can be recycled. Please send old packaging materials to the relevant collection and reprocessing system. This way, you will contribute to the recycling of raw materials and the avoidance of waste.

Explanation of warranty terms

This W&H product has been manufactured with great care by highly qualified specialists. A wide variety of tests and controls guarantee faultless operation. Please note that claims under warranty can only be validated when all the directions in the instructions for use have been followed.

As manufacturer, W&H is liable for material or manufacturing defects within a warranty period of 24 months from the date of purchase.

We accept no responsibility for damage caused by incorrect handling or by repairs carried out by third parties not authorized to do so by W&H!

Claims under warranty – accompanied by proof of purchase – must be sent to the vendor or to an authorized W&H service partner. The provision of service under warranty extends neither the warranty period nor any other guarantee period.

24 months warranty

Authorized W&H service partners

Find you nearest W&H service partner at <http://wh.com>

Simply go to the menu option »Service« for full details. Alternatively please contact:

W&H (UK) LIMITED, 6 Stroud Wood Business Centre, Park Street, St Albans, Herts AL2 2NJ, United Kingdom
t + 44 1727 874990, f + 44 1727 874628, E-Mail: technical.uk@wh.com

W&H Impex Inc., 6490 Hawthorne Drive, Windsor, Ontario, N8T 1J9, Canada
t + 1 800 2656277, + 1 519 9446739, f + 1 519 9746121, E-Mail: service.ca@wh.com

W&H Impex Inc., 14300 Henn Rd., Dearborn, MI 48126, USA
t + 1 800 2656277, + 1 519 9446739, f + 1 519 9746121, E-Mail: service.us@wh.com

W&H Austria GmbH, Ignaz-Glaser-Straße 53, 5111 Bürmoos, Austria
t + 43 6274 6236-239, f + 43 6274 6236-890, E-Mail: office.at@wh.com

A-DEC AUSTRALIA CO. INC., Unit 8, 5-9 Ricketty Street, Mascot NWS 2020, Australia
t + 61 2 83324000, f + 61 2 83324099, E-Mail: a-dec@a-dec.com.au

Manufacturer

W&H Dentalwerk Bürmoos GmbH

Ignaz-Glaser-Straße 53, 5111 Bürmoos, Austria

t + 43 6274 6236-0,

office@wh.com

f + 43 6274 6236-55

wh.com

Form-Nr. 50745 AEN

Rev. 003 / 20.01.2015

Subject to alterations